

### Features

- 3A Peak Output Current
- Wide Operating Voltage Range: 4.5V to 35V
- -40°C to +125°C Operating Temperature Range
- Latch-up Protected to 3A
- Fast Rise and Fall Times
- Low Power Consumption

### Applications

- MOSFET Driver
- Switching Power Supplies
- Motor Controls
- DC to DC Converters
- Pulse Transformer Driver

### Description

The IX4423, IX4424, and IX4425 are dual high-speed, low-side gate drivers. Each of the two outputs can source and sink 3A of peak current with rise and fall times of less than 10ns. The inputs of each driver are TTL and CMOS compatible, and are virtually immune to latch-up. Low propagation delay times and fast, matched rise and fall times make the IX4423, IX4424, and IX4425 ideal for high-frequency and high-power applications.

The IX4423 is configured as a dual inverting driver; the IX4424 is configured as a dual non-inverting driver; and the IX4425 is configured with one inverting driver and one non-inverting driver. All three devices are available in a standard 8-pin SOIC package.

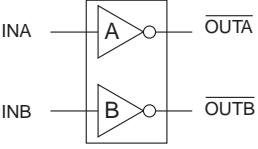
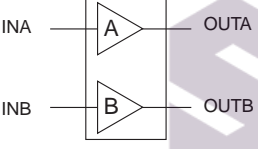
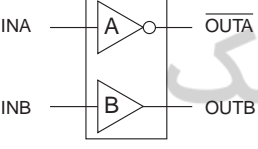

### Ordering Information

Logic Configuration	Part Number	Package Type	Packing Method	Quantity
	IX4423N	8-Pin SOIC	Tube	100
	IX4423NTR	8-Pin SOIC	Tape & Reel	2000
	IX4424N	8-Pin SOIC	Tube	100
	IX4424NTR	8-Pin SOIC	Tape & Reel	2000
	IX4425N	8-Pin SOIC	Tube	100
	IX4425NTR	8-Pin SOIC	Tape & Reel	2000

<b>1. Specifications</b> .....	<b>3</b>
1.1 Pin Configurations .....	3
1.2 Pin Definitions .....	3
1.3 Absolute Maximum Ratings .....	3
1.4 Recommended Operating Conditions .....	3
1.5 Electrical Characteristics: $T_A = 25^\circ\text{C}$ .....	4
1.6 Electrical Characteristics: $T_A = -40^\circ\text{C}$ to $+125^\circ\text{C}$ .....	5
1.7 Thermal Characteristics .....	6
<b>2. IX4423-24-25 Performance</b> .....	<b>6</b>
2.1 Timing Diagrams .....	6
2.2 Characteristics Test Diagram .....	6
<b>3. Block Diagrams &amp; Truth Tables</b> .....	<b>7</b>
3.1 IX4423 .....	7
3.2 IX4425 .....	7
3.3 IX4424 .....	7
<b>4. Typical Performance Characteristics</b> .....	<b>8</b>
<b>5. Manufacturing Information</b> .....	<b>11</b>
5.1 Moisture Sensitivity .....	11
5.2 ESD Sensitivity .....	11
5.3 Soldering Profile .....	11
5.4 Board Wash .....	11
5.5 Mechanical Dimensions .....	12

**SKYTECH**

تهیه و توزیع قطعات الکترونیک

# 1 Specifications

## 1.1 Pin Configurations

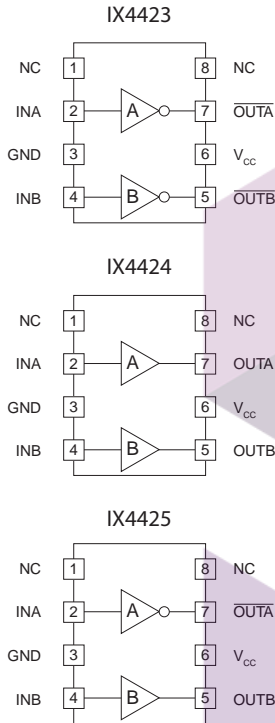

## 1.2 Pin Definitions

Pin Name	Description
INA	Channel A Logic Input
INB	Channel B Logic Input
OUTA OUTA	Channel A Output - Sources or sinks current to turn-on or turn-off a discrete MOSFET or IGBT
OUTB OUTB	Channel B Output - Sources or sinks current to turn on or turn off a discrete MOSFET or IGBT
V <sub>CC</sub>	Supply Voltage - Provides power to the device
GND	Ground - Common ground reference for the device
NC	No Connection

## 1.3 Absolute Maximum Ratings

Parameter	Symbol	Minimum	Maximum	Units
Supply Voltage	V <sub>CC</sub>	-0.3	35	V
Input Voltage	V <sub>IN</sub>	-5.0	V <sub>CC</sub> +0.3	V
Output Current	I <sub>OUT</sub>	-	±3	A
Junction Temperature	T <sub>J</sub>	-55	+150	°C
Storage Temperature	T <sub>STG</sub>	-65	+150	°C

Unless otherwise specified, absolute maximum electrical ratings are at 25°C

Absolute maximum ratings are stress ratings. Stresses in excess of these ratings can cause permanent damage to the device. Functional operation of the device at conditions beyond those indicated in the Recommended Operating Conditions table and other operational sections of this data sheet is not implied.

## 1.4 Recommended Operating Conditions

Parameter	Symbol	Minimum	Maximum	Units
Supply Voltage	V <sub>CC</sub>	4.5	30	V
Operating Temperature Range	T <sub>A</sub>	-40	+125	°C

**1.5 Electrical Characteristics:  $T_A = 25^\circ\text{C}$**

Test Conditions:  $4.5\text{V} \leq V_{CC} \leq 18\text{V}$ .

Parameter	Conditions	Symbol	Minimum	Typical	Maximum	Units
Input Voltage, High	-	$V_{IH}$	3	-	-	V
Input Voltage, Low	-	$V_{IL}$	-	-	0.8	
Input Current	$0\text{V} \leq V_{IN} \leq V_{CC}$	$I_{IN}$	-	-	$\pm 10$	$\mu\text{A}$
Output Voltage, High	-	$V_{OH}$	$V_{CC}-0.025$	-	-	V
Output Voltage, Low	-	$V_{OL}$	-	-	0.025	
Output Resistance, High State	$V_{CC}=18\text{V}, I_{OUT}=-100\text{mA}$	$R_{OH}$	-	2.5	4	$\Omega$
Output Resistance, Low State	$V_{CC}=18\text{V}, I_{OUT}=100\text{mA}$	$R_{OL}$	-	1.5	3	
Rise Time	$V_{CC}=18\text{V}, C_{LOAD}=1000\text{pF}$	$t_R$	-	18	35	ns
Fall Time	$V_{CC}=18\text{V}, C_{LOAD}=1000\text{pF}$	$t_F$	-	18	35	
On-Time Propagation Delay	$V_{CC}=18\text{V}, C_{LOAD}=1000\text{pF}$	$t_{on}$	-	35	75	
Off-Time Propagation Delay	$V_{CC}=18\text{V}, C_{LOAD}=1000\text{pF}$	$t_{off}$	-	38	75	
Power Supply Current	$V_{INA}=V_{INB}=3.5\text{V}$	$I_{CC}$	-	1	3	mA
	$V_{INA}=V_{INB}=0\text{V}$		-	0.001	0.01	

**SKYTECH**

تهیه و توزیع قطعات الکترونیک

**1.6 Electrical Characteristics:  $T_A = -40^\circ\text{C}$  to  $+125^\circ\text{C}$**

Test Conditions:  $4.5\text{V} \leq V_{CC} \leq 18\text{V}$ .

Parameter	Conditions	Symbol	Minimum	Maximum	Units
Input Voltage, High	-	$V_{IH}$	3.3	-	V
Input Voltage, Low	-	$V_{IL}$	-	0.65	
Input Current	$0\text{V} \leq V_{IN} \leq V_{CC}$	$I_{IN}$	-	$\pm 10$	$\mu\text{A}$
Output Voltage, High	-	$V_{OH}$	$V_{CC}-0.025$	-	V
Output Voltage, Low	-	$V_{OL}$	-	0.025	
Output Resistance, High State	$V_{CC}=18\text{V}, I_{OUT}=-100\text{mA}$	$R_{OH}$	-	6	$\Omega$
Output Resistance, Low State	$V_{CC}=18\text{V}, I_{OUT}=100\text{mA}$	$R_{OL}$	-	5	
Rise Time	$V_{CC}=18\text{V}, C_{LOAD}=1000\text{pF}$	$t_R$	-	60	ns
Fall Time	$V_{CC}=18\text{V}, C_{LOAD}=1000\text{pF}$	$t_F$	-	60	
On-Time Propagation Delay	$V_{CC}=18\text{V}, C_{LOAD}=1000\text{pF}$	$t_{on}$	-	100	
Off-Time Propagation Delay	$V_{CC}=18\text{V}, C_{LOAD}=1000\text{pF}$	$t_{off}$	-	100	
Power Supply Current	$V_{INA}=V_{INB}=3.5\text{V}$	$I_{CC}$	-	3.5	mA
	$V_{INA}=V_{INB}=0\text{V}$		-	0.15	

**SKYTECH**

تهیه و توزیع قطعات الکترونیک

### 1.7 Thermal Characteristics

Package	Parameter	Symbol	Rating	Units
8-Pin SOIC	Thermal Resistance, Junction-to-Ambient	$\theta_{JA}$	120	$^{\circ}\text{C}/\text{W}$

## 2 IX4423-24-25 Performance

### 2.1 Timing Diagrams

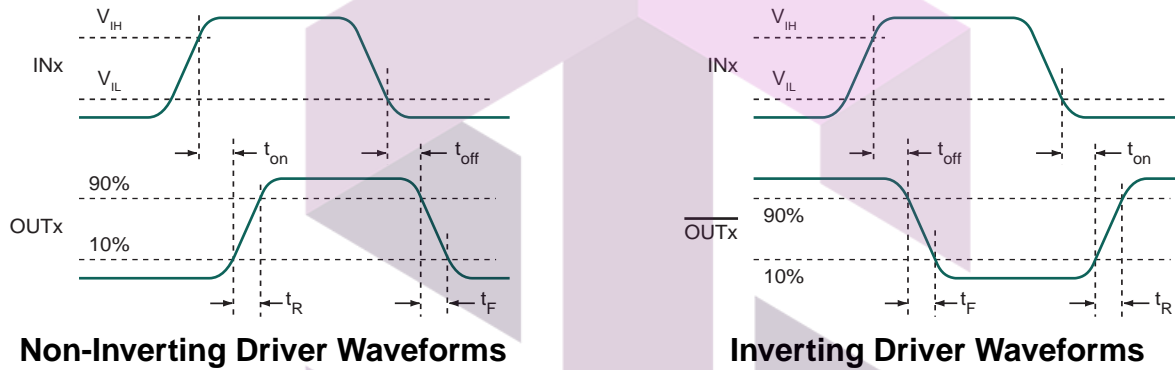

### 2.2 Characteristics Test Diagram

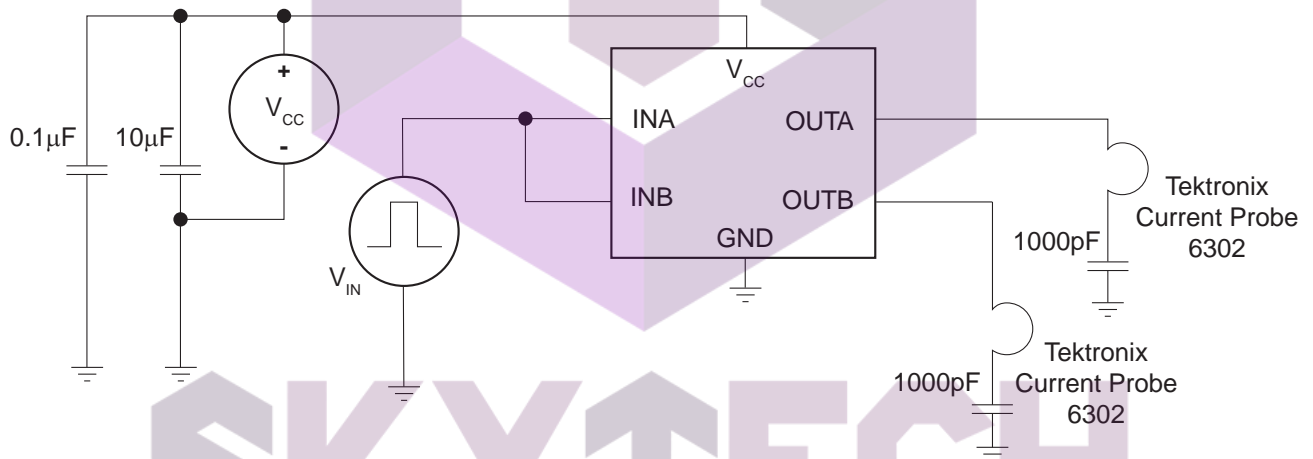

SKYTECH

تهیه و توزیع قطعات الکترونیک

### 3 Block Diagrams & Truth Tables

#### 3.1 IX4423

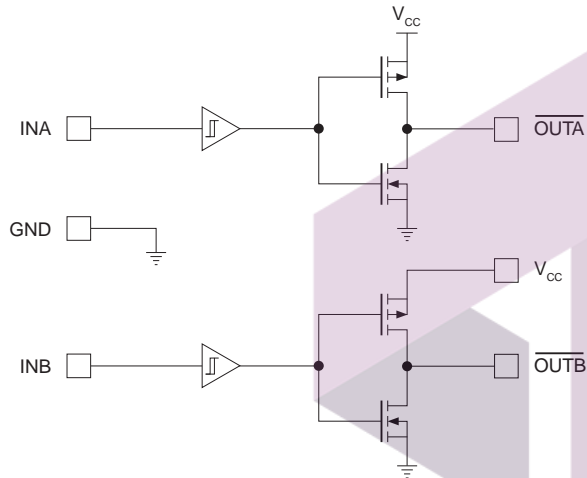

IN <sub>x</sub>	OUT <sub>x</sub>
0	1
1	0

#### 3.3 IX4424

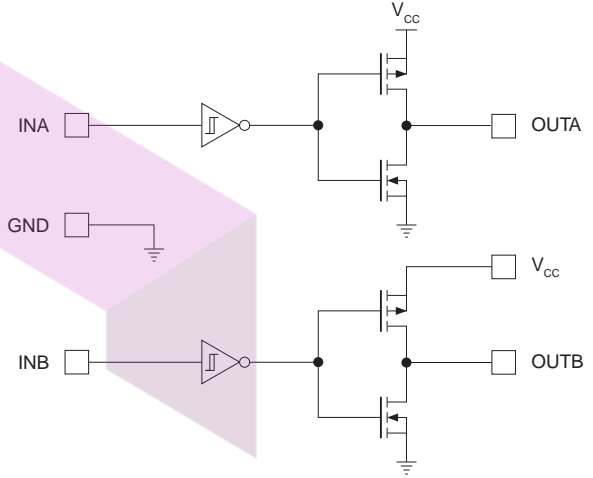

IN <sub>x</sub>	OUT <sub>x</sub>
0	0
1	1

#### 3.2 IX4425

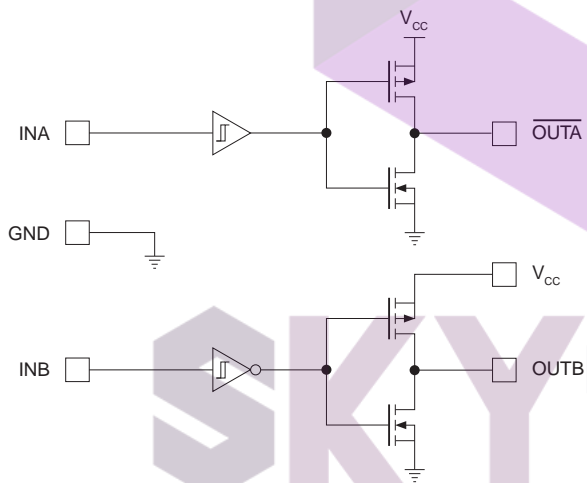

INA	OUTA
0	1
1	0
INB	OUTB
0	0
1	1

4 Typical Performance Characteristics

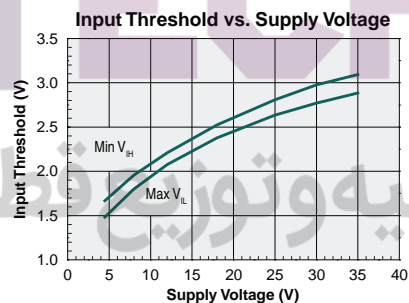
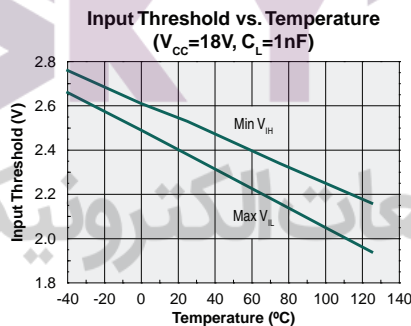
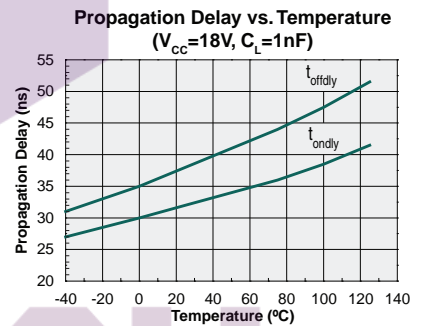
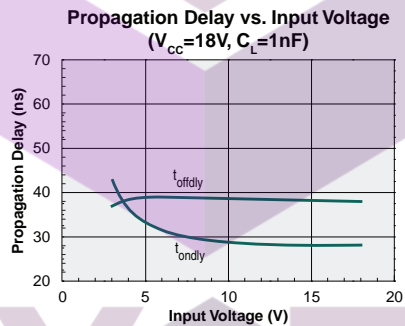
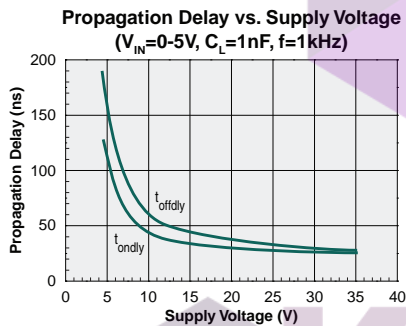
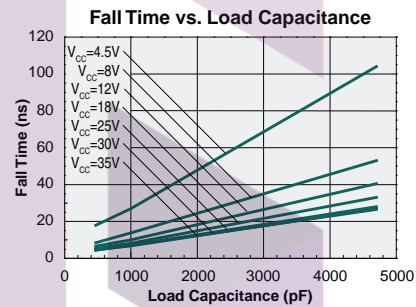
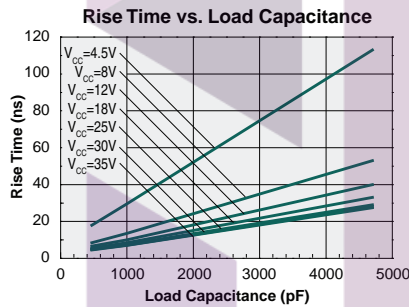
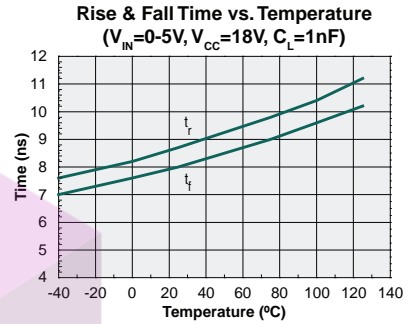
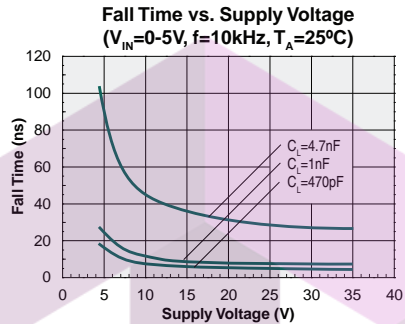
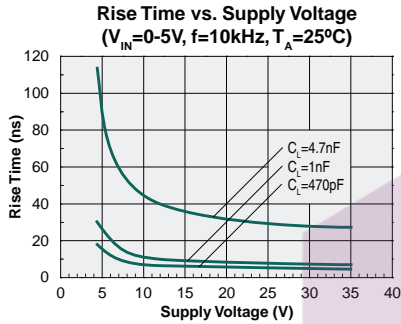



Supply Current vs. Load Capacitance  
Both Outputs Active  
( $V_{CC}=8V$ )

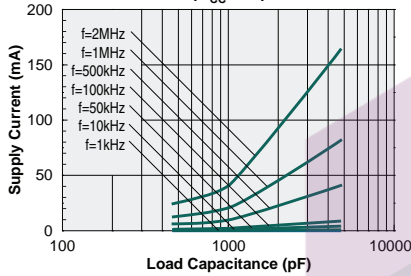

Supply Current vs. Load Capacitance  
Both Outputs Active  
( $V_{CC}=12V$ )

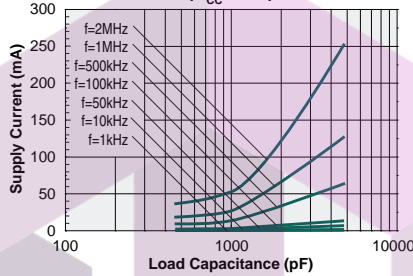

Supply Current vs. Load Capacitance  
Both Outputs Active  
( $V_{CC}=18V$ )

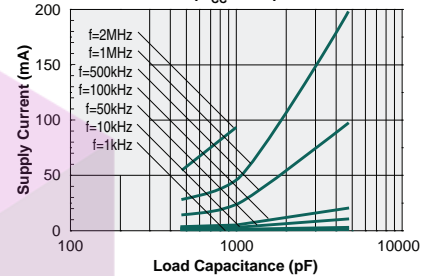

Supply Current vs. Load Capacitance  
Both Outputs Active  
( $V_{CC}=35V$ )

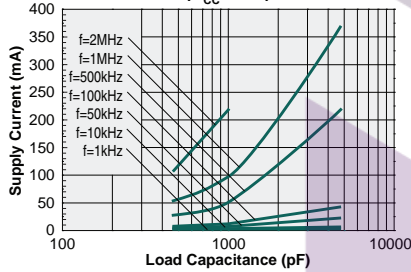

Supply Current vs. Frequency  
Both Outputs Active  
( $V_{CC}=8V$ )

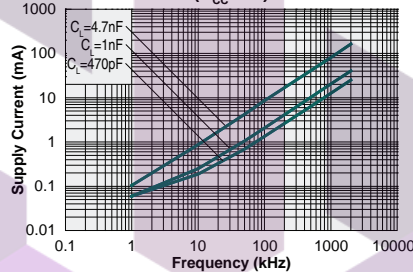

Supply Current vs. Frequency  
Both Outputs Active  
( $V_{CC}=12V$ )

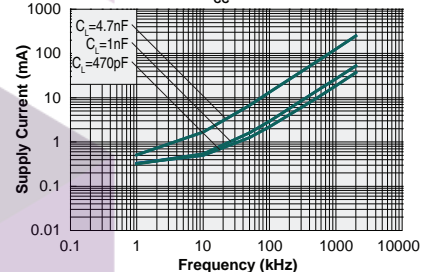

Supply Current vs. Frequency  
Both Outputs Active  
( $V_{CC}=18V$ )

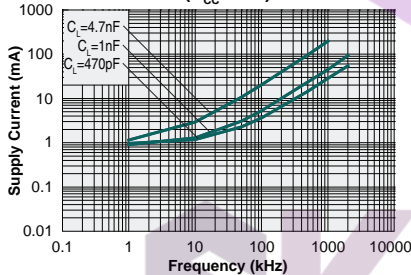

Supply Current vs. Frequency  
Both Outputs Active  
( $V_{CC}=35V$ )

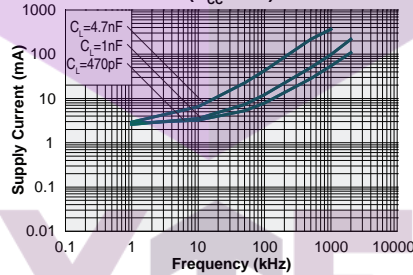

Quiescent Supply Current  
vs. Temperature  
( $V_{CC}=18V$ )

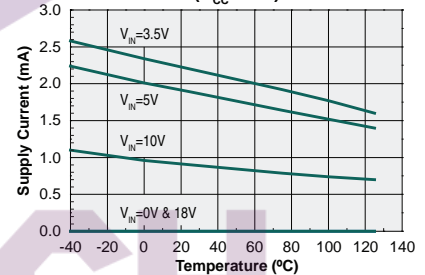

Dynamic Supply Current  
vs. Temperature  
( $V_{IN}=0-5V, V_{CC}=18V, C_L=1nF, f=1kHz$ )

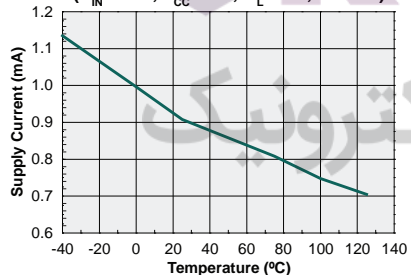

Output Source Current  
vs. Supply Voltage  
( $C_L=27nF$ )

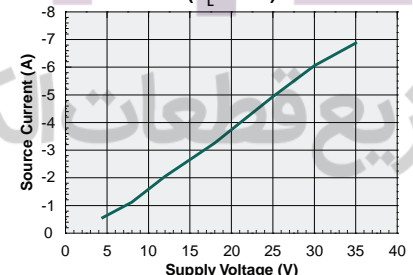

Output Sink Current  
vs. Supply Voltage  
( $C_L=27nF$ )

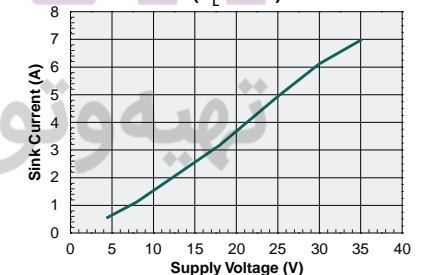

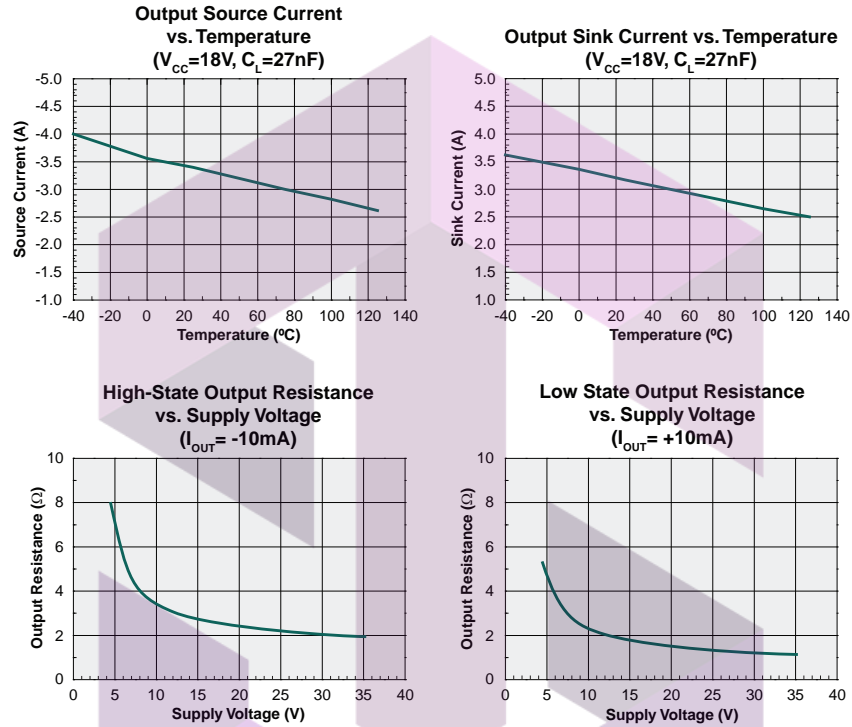

SKYTECH

تهیه و توزیع قطعات الکترونیک

## 5 Manufacturing Information

### 5.1 Moisture Sensitivity



All plastic encapsulated semiconductor packages are susceptible to moisture ingress. IXYS Integrated Circuits Division classifies its plastic encapsulated devices for moisture sensitivity according to the latest version of the joint industry standard, **IPC/JEDEC J-STD-020**, in force at the time of product evaluation.

We test all of our products to the maximum conditions set forth in the standard, and guarantee proper operation of our devices when handled according to the limitations and information in that standard as well as to any limitations set forth in the information or standards referenced below.

Failure to adhere to the warnings or limitations as established by the listed specifications could result in reduced product performance, reduction of operable life, and/or reduction of overall reliability.

This product carries a **Moisture Sensitivity Level (MSL)** classification as shown below, and should be handled according to the requirements of the latest version of the joint industry standard **IPC/JEDEC J-STD-033**.

Device	Moisture Sensitivity Level (MSL) Classification
IX4423N / IX4424N / IX4425N	MSL 1

### 5.2 ESD Sensitivity



This product is **ESD Sensitive**, and should be handled according to the industry standard **JESD-625**.

### 5.3 Soldering Profile

Provided in the table below is the Classification Temperature ( $T_C$ ) of this product and the maximum dwell time the body temperature of this device may be ( $T_C - 5$ )°C or greater. The classification temperature sets the Maximum Body Temperature allowed for this device during lead-free reflow processes. For through-hole devices, and any other processes, the guidelines of **J-STD-020** must be observed.

Device	Classification Temperature ( $T_C$ )	Dwell Time ( $t_p$ )	Max Reflow Cycles
IX4423N / IX4424N / IX4425N	260°C	30 seconds	3

### 5.4 Board Wash

IXYS Integrated Circuits Division recommends the use of no-clean flux formulations. Board washing to reduce or remove flux residue following the solder reflow process is acceptable provided proper precautions are taken to prevent damage to the device. These precautions include but are not limited to: using a low pressure wash and providing a follow up bake cycle sufficient to remove any moisture trapped within the device due to the washing process. Due to the variability of the wash parameters used to clean the board, determination of the bake temperature and duration necessary to remove the moisture trapped within the package is the responsibility of the user (assembler). Cleaning or drying methods that employ ultrasonic energy may damage the device and should not be used. Additionally, the device must not be exposed to flux or solvents that are Chlorine- or Fluorine-based



### 5.5 Mechanical Dimensions

#### 5.5.1 "N" Package (8-Pin SOIC)

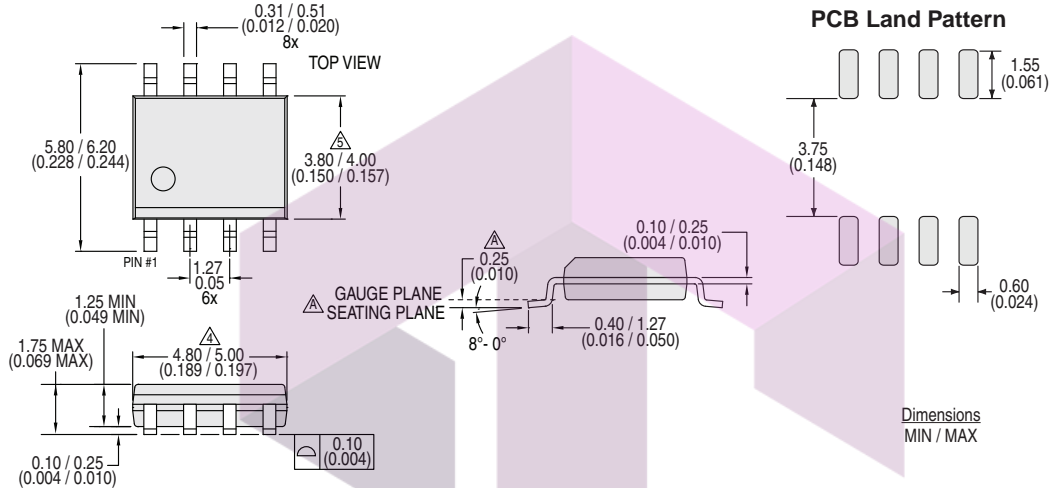

**Notes:**

1. Controlling dimension: millimeters.
2. All dimensions are in mm (inches).
3. This package conforms to JEDEC Standard MS-012, variation AA, Rev. F.
4. Dimension does not include mold flash, protrusions, or gate burrs. Mold flash, protrusions, or gate burrs shall not exceed 0.15mm per end.
5. Dimension does not include interlead flash or protrusion. Interlead flash or protrusion shall not exceed 0.25mm per side.
6. Lead thickness includes plating.

#### 5.5.2 "N" Package Tape & Reel

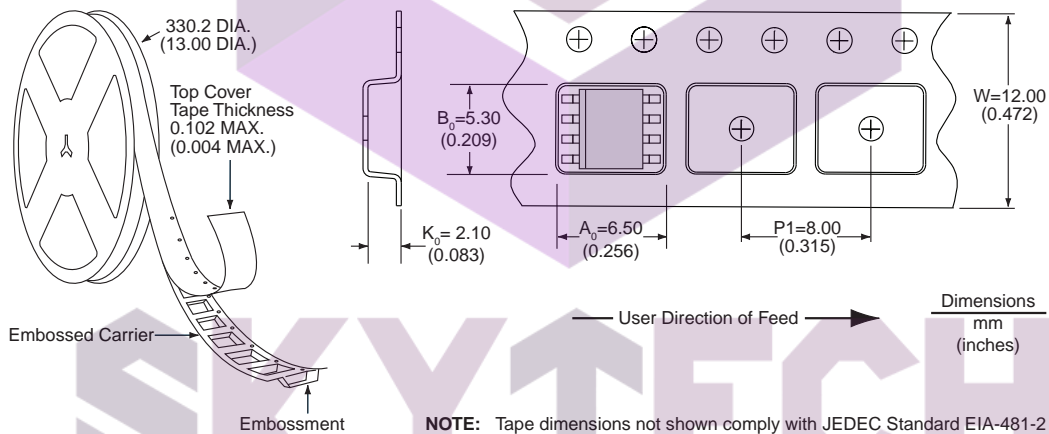

For additional information please visit our website at: [www.ixysic.com](http://www.ixysic.com)

IXYS Integrated Circuits Division makes no representations or warranties with respect to the accuracy or completeness of the contents of this publication and reserves the right to make changes to specifications and product descriptions at any time without notice. Neither circuit patent licenses nor indemnity are expressed or implied. Except as set forth in IXYS Integrated Circuits Division's Standard Terms and Conditions of Sale, IXYS Integrated Circuits Division assumes no liability whatsoever, and disclaims any express or implied warranty, relating to its products including, but not limited to, the implied warranty of merchantability, fitness for a particular purpose, or infringement of any intellectual property right.

The products described in this document are not designed, intended, authorized or warranted for use as components in systems intended for surgical implant into the body, or in other applications intended to support or sustain life, or where malfunction of IXYS Integrated Circuits Division's product may result in direct physical harm, injury, or death to a person or severe property or environmental damage. IXYS Integrated Circuits Division reserves the right to discontinue or make changes to its products at any time without notice.

Specification: DS-IX4423-24-25\_R02  
 ©Copyright 2017, IXYS Integrated Circuits Division  
 All rights reserved. Printed in USA.  
 10/25/2017